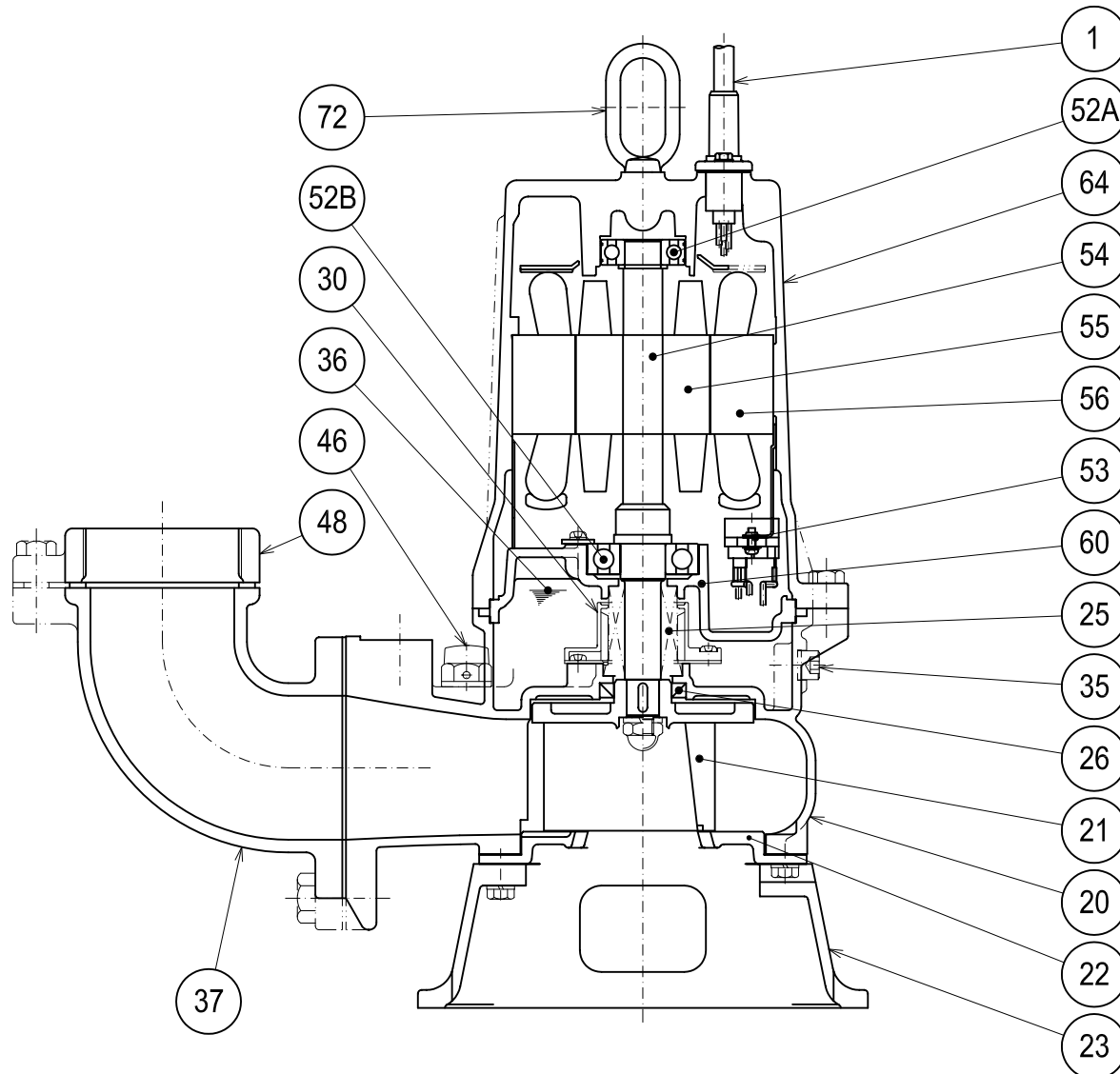

**TSURUMI PUMP****C-SERIES
CUTTER - TYPE - SEWAGE & WASTEWATER PUMPS****SECTIONAL VIEW****80C21.5-CR -62**

PART#	DESCRIPTION	MAIN MATERIAL / NOTE	RELATED ASTM,AISI CODE	RELATED EN CODE	QTY
1	Power Cable	PVC Sheath AWG 16/4-32ft			1
20	Pump Casing	Cast Iron	A48M Class30B	EN 1561 GJL-200	1
21	Impeller	Cast Iron W/Tungsten Carbide	A48M Class30B	EN 1561 GJL-200	1
22	Suction Cover	High Chrome Cast Iron	A532 Class III TypeA	DIN 1695 G-X260Cr27	1
23	Suction Strainer	Ductile Cast Iron	A536 65-45-12	EN 1563 GJS-450-10	1
25	Mechanical Seal	Silicon Carbide / H-20			1
26	Oil Seal	NBR / TC32488			1
30	Oil Lifter	PBT Resin W/GF40			1
35	Oil Plug	Stainless Steel	S 30400	1.4301	1
36	Lubricant	Turbine Oil ISO VG32 or SAE 10W-20			
37	Discharge Bend	Cast Iron	A48M Class30B	EN 1561 GJL-200	1
46	Air Release Valve	Nylon			1
48	Companion Flange	Cast Iron / NPT 3"	A48M Class30B	EN 1561 GJL-200	1
52A	Upper Bearing	AC-#6204ZZC3			1
52B	Lower Bearing	#6305ZZC3			1
53	Motor Protector				1
54	Shaft	Stainless Steel	S 42000	1.4028	1
55	Rotor				1
56	Stator				1
60	Bearing Housing	Cast Iron	A48M Class25B	EN 1561 GJL-150	1
64	Motor Housing	Cast Iron	A48M Class25B	EN 1561 GJL-150	1
72	Lifting Lug Bolt	Stainless Steel	S 30400	1.4301	1